

UNI-T®

UT108 / 109



Certificate No. 956661

Operating Manual



**Handheld Automotive
Multi-Purpose Meters**

P/N:110401102526

UNI-T®

UT108/109
Handheld Automotive Multi-Purpose Meters
Operating Manual

Table of Contents

Title	Page
Overview	5
Unpacking Inspection	6
Safety Information	7
Rules for Safe Operation	8
Automotive Servicing Safety Guide	10
International Electrical Symbols	13
The Meter Structure	14
Rotary Switch	15
Functional Buttons	16
Display Symbols	18
Measurement Operation	20
Part 1 Multimeter Basic Testing	20
A. AC/DC Voltage Testing	20
B. DC millivoltage Testing	23
C. AC/DC Current Testing	25
D. Resistance Testing	28
E. Continuity Testing	30

Title	Page
F. Diode Testing -----	33
G. Capacitance Testing -----	36
H. Frequency Testing -----	38
I. Temperature Measurement (UT109 only) -----	40
J. Dwell Testing -----	42
K. Engine Tach (Rotation Speed) Testing “RPMx10” -----	44
L. Operation of Hold Mode -----	46
M. RANGE button -----	46
N. MAX MIN button -----	46
O. Data Outputting -----	47
P. Display backlight -----	47
Q. The BLUE button -----	47
R. Automatic power off -----	47
Part 2 Diagnosis of Automotive Troubles -----	48
A. Fuse Testing: Check the fuse to see if it is blown out. -----	48
B. Switch Testing: Check the switch to see if it can work correctly. -----	49
C. Solenoid or Relay Testing -----	49
D. Starting/Charging System Testing -----	50

Title	Page
E. Battery Power Consumption Testing when the Engine Is off -----	51
F. Trigger Voltage Battery Load Testing -----	52
G. Voltage Drop Testing -----	54
H. Charging System Voltage Testing -----	56
I. Ignition System Testing -----	57
1. Ignition Coil Testing -----	57
2. Ignition System High Voltage Damper Testing -----	60
3. Hall Switch/Sensor Testing -----	62
4. Magnetic Resistance Sensor -----	64
5. RPMx10 Testing -----	65
6. Fuel System Testing -----	67
J. Engine Sensor Testing -----	69
1. Oxygen Sensor -----	70
2. Temperature Sensor -----	72
3. Position Sensor -----	73
4. Absolute Pressure (MAP) and Baro Sensor -----	75
5. Mass Air Flow (MAF) Sensor -----	78

Title	Page
General Specifications	79
Accurate Specifications	81
A. DC Voltage	81
B. AC Voltage	81
C. DC millivoltage	82
D. AC Current	82
E. DC Current	83
F. Resistance	84
G. Capacitance	84
H. Frequency	85
I. Diode	86
J. Continuity	86
K. Dwell	87
L. Tach (Rotation Speed)	87
M. Temperature	88
Maintenance	89
A. General Services	89
B. Replacing the Fuses	90
C. Replacing the Battery	92

Overview

This Operating Manual covers information on safety and cautions. Please read the relevant information carefully and observe all the Warnings and Notes strictly.



Warning

To avoid electric shock or personal injury, read the “Safety Information” and “Rules for Safe Operation” carefully before using the Meter.

Automotive Digital Multimeter Model UT108/UT109 (hereafter referred to as “the Meter”) is a 4000 counts, 3-3/4 digits manual ranging meter. The meter uses large scale of integrated circuit with integrated A/D converter as its core. Spotting a unique design with an extra large LCD display. Connect Test Leads display, full overload protection and unique outlook design. For this reason, it emerges as an electric meter with more outstanding performance for safer operation than other meters. In addition to the Dwell, Tach and Data Hold feature, the Meter can be used to test the AC/DC voltage, AC/DC current, resistance, frequency, diode, continuity, and Capacitance.

UT109 has an extra temperature feature.

Unpacking Inspection

Open the package case and take out the Meter. Check the following items carefully to see any missing or damaged part:

Item	Description	Qty
1	English Operating Manual	1 piece
2	Test Lead	1 pair
3	K-Type Point Contact Temperature Probe. (UT109 only and It is only suitable for measuring temperature under 230℃)	1 pair
4	Alligator Clip	1 piece
5	RS232C interface cable	1 piece
6	CD-ROM	1 piece
7	9V Battery (NEDA 1604, 6F22 or 006P)	1 piece
8	Multi-Purpose Socket (Optional)	1 piece
9	USB interface cable (Optional)	1 piece

In the event you find any missing or damage, please contact your dealer immediately.

Safety Information

This Meter complies with standards IEC61010: in pollution degree 2, overvoltage category (CATIII 1000V, CATIV 600V) and double insulation.

CAT III: Distribution level, fixed installation, with smaller transient overvoltages than CAT IV

CAT IV: Primary supply level, overhead lines, cable systems ets.

Use the Meter only as specified in this operating manual, otherwise the protection provided by the Meter may be impaired.

International electrical symbols used on the Meter and in this Operating Manual are explained on page 13.

Rules For Safe Operation



Warning

To avoid possible electric shock or personal injury, and to avoid possible damage to the Meter or to the equipment under test, adhere to the following rules:

- Before using the Meter inspect the case. Do not use the Meter if it is damaged or the case (or part of the case) is removed. Look for cracks or missing plastic. Pay attention to the insulation around the connectors.
- Inspect the test leads for damaged insulation or exposed metal. Check the test leads for continuity. Replace damaged test leads with identical model number or electrical specifications before using the Meter.
- When using the test leads, keep your fingers behind the finger guards.
- Do not apply more than the rated voltage, as marked on the Meter, between the terminals or between any terminal and grounding.
- When the meter working at an effective voltage over 60V in DC or 30V rms in AC, special care should be taken for there is danger of electric shock.
- Use the proper terminals, function, and range for your measurements.
- The rotary switch should be placed in the right position and no any changeover of range shall be made during measurement is conducted to prevent damage of the

Meter.

- Disconnect circuit power and discharge all high-voltage capacitors before testing, resistance, diodes or continuity.
- Before measuring current, check the fuse is ok. Before connecting the Meter in serial to the tested in-circuit, disconnect in-circuit power.
- If the value of current to be measured is unknown, use the maximum measurement position, and reduce the range step by step until a satisfactory reading is obtained
- Replace the battery as soon as the battery indicator appears. With a low battery, the Meter might produce false readings that can lead to electric shock and personal injury.
- When servicing the Meter, use only the same model number or identical electrical specifications replacement parts.
- The internal circuit of the Meter shall not be altered at will to avoid damage of the Meter and any accident.
- Soft cloth and mild detergent should be used to clean the surface of the Meter when servicing. No abrasive and solvent should be used to prevent the surface of the Meter from corrosion, damage and accident.
- Turn off the Meter when it is not in use and take out the battery when not using for a long time.
- Do not use or store the Meter in an environment of high temperature, humidity, explosive, inflammable and strong magnetic field. The performance of the Meter may

deteriorate after dampened.

- The Meter is suitable for indoor use.

Automotive Servicing Safety Guide



Warning

As some automobiles are installed with safety air bags, you must pay attention to the cautions in the automotive servicing manual when you are working around the components and wiring of the air bags, or any carelessness will open an air bag, resulting in some personal injury. Note that the air bag will also be opened for a few minutes after the ignition lock is closed (or even when the automotive battery is cut off), which is driven by the special energy reserve.

To prevent an accident from causing any personal injury or any damage to an automobile or any of its meters, please read the following safety guidelines and testing procedure in earnest:

- Wear protective eyeglasses which meet safety requirements.
- Operate the automobile in a well-ventilated place so as to prevent the inhalation of any toxic tail gas.
- Keep your own tools and testing instruments far from all the heater components of the

operating engine.

- Ensure that the automobile has stopped (automatic transmission) or put into neutral gear (manual transmission) and be sure that it is equipped with brakes and the wheels have been locked.
- Do not place any tool on the automotive battery which will cause a short circuit of the electrodes and in turn lead to any personal injury or damage to a tool or battery.
- Smoking or striking a light near the automobile is prohibited.
- Pay attention to ignition coil, an ignition lead or a spark plug socket because these components are provided with high voltages when the automobile is operating.
- To connect or cut off an electronic component, close the ignition lock.
- Pay attention to the automotive producer's cautions, notes and servicing procedures.

All the information, explanations and detailed descriptions in the operation manual have originated from the industrial information recently published. It is impossible to prove the accuracy and completeness of the information, of which we shall not be responsible for the assumption.

A.The data of the automotive servicing manual have originated from the automotive servicing information.











1. Contact the local distributors of automotive components.

2. Contact the local retailers of automotive components.
3. Contact the local libraries to look up any book for the proofreading of your automotive servicing manual so as to provide you with the latest information.

B.before the diagnosis of any trouble opens the engine hood to make a thorough visual inspection. You will find the causes for many of your problems to be solved, which will save you a lot of time.

1. Has the automobile recently been serviced? Has the same problem sometimes occurred where the trouble lies?
2. Do not try to find any short cut. Check the hoses and leads where it is probably very difficult to find out where any trouble lies.
3. Check any trouble with the air purifier or pipeline system.
4. Check any damage to any sensor or the driving gear.
5. Check the ignition lead: any breakage of any terminal, crack on any spark plug or breakage at the insulation of the ignition lead.
6. Check all the vacuum hoses: any right line, shrinkage, bend, crack, fracture or damage.
7. Check the leads: any connection of sharp edges, connection of hot surfaces (such as exhaust manifold), shrinkage, burn or scratch at the insulation or right line connection.
8. Check circuit connections: any pin corrosion, bend or damage, inappropriate connection position or damaged electrode lead.

International Electrical Symbols

	AC (Alternating Current).
	DC (Direct Current)
	Grounding.
	AC or DC
	Diode
	Double Insulated.
	Deficiency of Built-In Battery.
	Fuse.
	Warning. Refer to the Operating Manual.
	Conforms to Standards of European Union.

The Meter Structure (see figure 1)

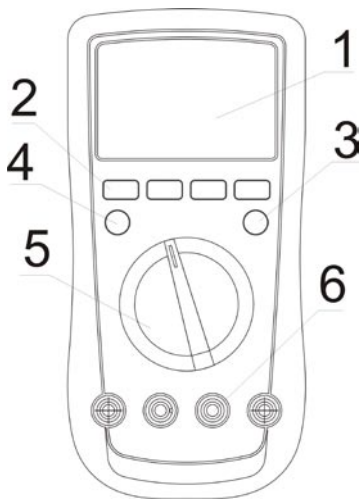

1. LCD display
2. Functional buttons
3. SELECT button
4. Power button
5. Rotary Switch
6. Input Terminals



(Figure 1)

Rotary Switch

Below table indicated for information about the rotary switch positions.

V	AC or DC Voltage Measurement.
mV	millivoltage Measurement.
°C	The unit of temperature, °C: Centigrade temperature (UT109 only)
°F	The unit of temperature, °F: Fahrenheit temperature (UT109 only)
Ω	Resistance Measurement.
	Capacitance measurement
	Continuity Test,
	Diode Test.
Hz	Frequency Measurement,
μA	Current measurement, unit: μA
mA	Current measurement, unit: mA
A	Current measurement, unit: A
RPM×10	Automotive engine tach testing (Displayed Reading x 10), Unit: rpm
Dwell	Automotive ignition dwell testing, Unit: degree

Functional Buttons (see figure 2)

Below table indicated for information about the functional button operations

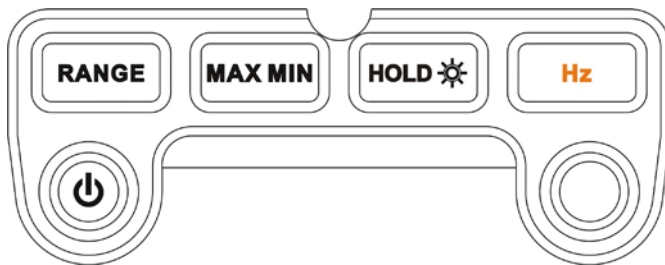



Figure 2

Button	Operation Performed
	Turn the power on and off.
HOLD / 	<ul style="list-style-type: none"> ● Press HOLD once to enter hold mode. ● Press HOLD again to exit hold mode and the present value is shown. ● Press and hold for 2 seconds to turn the display backlight on or off.
MAX/MIN	<p>Start recording of maximum and minimum values.</p> <p>Press to step the display through high (MAX) and low (MIN) readings at any time.</p>
Hz	<ul style="list-style-type: none"> ● Press once to enter Frequency measurement mode. ● Press and hold for 2 seconds to enter RS232C or USB mode. ● Press RANGE to enter the manual ranging mode;
RANGE	<ul style="list-style-type: none"> ● Press and hold RANGE for 2 seconds to return to auto ranging mode; ● Under RPM or Dwell testing mode, press RANGE to select 4CYL, 6CYL, or 8CYL.
SELECT	Press SELECT to select the alternate functions.

Display Symbols (see figure 3)

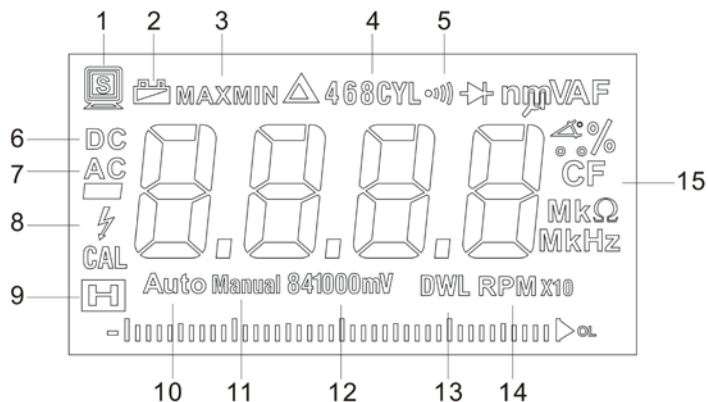



Figure 3

1	Data output is in progress.
2	The battery is low.  Warning: To avoid false readings, which could lead to possible electric shock or personal injury, replace the battery as soon as the battery indicator appears.
3	maximum or minimum reading displayed
4	4CYL, 6CYL, or 8CYL displayed
5	Test of continuity
6	Indicates for DC voltage or current
7	Indicates for AC voltage or current
8	Indicates for dangers
9	Data hold is active
10	The meter is in the auto range mode
11	The meter is in the auto range mode
12	Indicates for 841000mV range
13	Test of DWLL
14	Test of RPM
15	Indicates for units

Measurement Operation

Part 1 Multimeter Basic Testing

A. AC/DC Voltage Testing (see figure 4)



Warning

To avoid harms to you or damages to the Meter from electric shock, please do not attempt to measure voltages higher than 1000Vp although readings may be obtained.

Please take extra care when measuring high voltages to avoid electric shock.

To measure DC voltage, connect the Meter as follows:

1. Insert the red test lead into the **V** terminal and the black test lead into the **COM** terminal.
2. Set the rotary switch to an appropriate measurement position in **V** , press **BLUE** button to switch between AC and DC measurement mode.
3. AC voltage measurement display true rms value and press **H_z** button to obtain the frequency value, input amplitude and frequency response refer to accuracy specifications.
4. Connect the test leads across with the object being measured.
The measured value shows on the display.

Note

- If the value of voltage to be measured is unknown, use the maximum measurement position (1000V) and reduce the range step by step until a satisfactory reading is obtained.
- Please take extra care when measuring high voltages to avoid electric shock.
- In each range, the Meter has an input impedance of approx. $10\text{M}\Omega$. this loading effect can cause measurement errors in high impedance circuits. If the circuit impedance is less than or equal to $10\text{k}\Omega$, the error is negligible (0.1% or less).
- When voltage measurement has been completed, disconnect the connection between the testing leads and the circuit under test, and remove the testing leading away from the input terminals of the meter

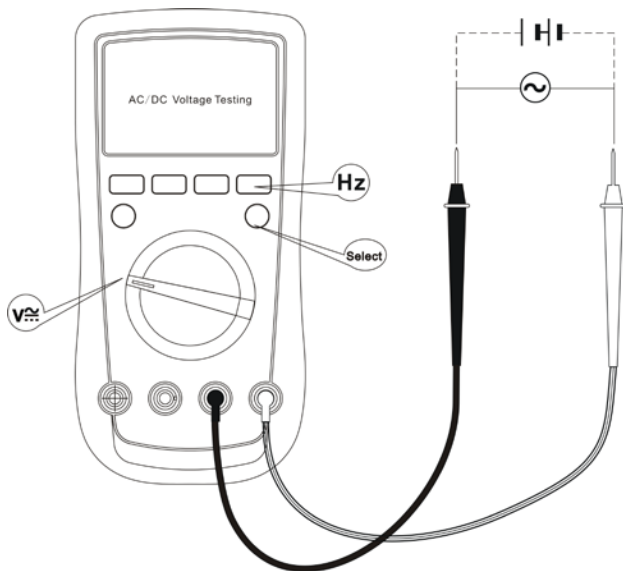

Figure 4

B. DC millivoltage Testing (see figure 5)



Warning

To avoid harms to you or damages to the Meter from electric shock, please do not attempt to measure voltages higher than the range although readings may be obtained.

When AC voltage measurement has been completed, disconnect the connection between the testing leads and the circuit under test.

To measure DC millivoltage, connect the Meter as follows:

1. Insert the red test lead into the **V** terminal and the black test lead into the **COM** terminal.
2. Set the rotary switch to an appropriate measurement position in **mV**.
3. Connect the test leads across with the object being measured.
The measured value shows on the display. Press **H_z** button to obtain the frequency value, input amplitude and frequency response refer to accuracy specifications.
4. The Meter has an input impedance of approx. 4000MΩ.

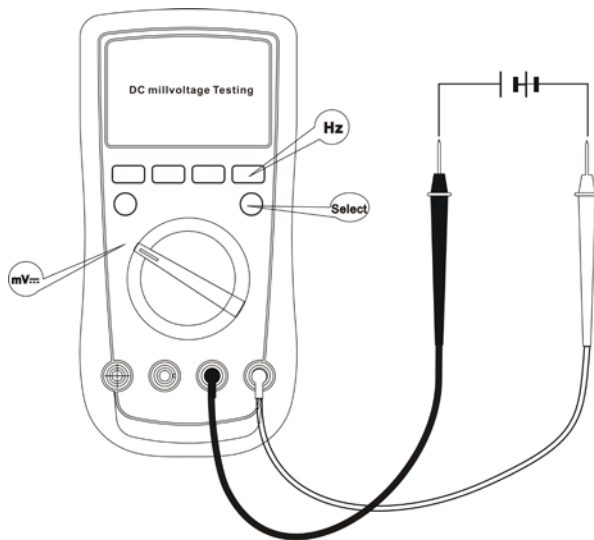

Figure 5

C. AC/DC Current Testing (see figure 6)



Warning

Before connecting the Meter in serial to the tested in-circuit, disconnect in-circuit power.

If the fuse burns out during measurement, the Meter may be damaged or the operator himself may be hurt.

Use proper terminals, function, and range for the measurement. When the testing leads are connected to the current terminals, do not parallel them across any circuit otherwise it will burn the fuse or damage to the Meter.

To measure AC/DC current, connect the Meter as follows:

1. Insert the red test lead into the “**μA, mA**” or “**A**” terminal and the black test lead into the **COM** terminal.
2. Set the rotary switch to an appropriate measurement position in “**μA, mA**” or “**A**” . Press blue button to switch between AC and DC measurement mode.
3. AC current measurement display true rms value and press **Hz** button to obtain the frequency value, input amplitude and frequency response refer to accuracy specifications.

4. Connect the test leads across with the object being measured.
The measured value shows on the display.

Note

- If the value of current to be measured is unknown, use the maximum measurement position 10A terminal, and reduce the range step by step until a satisfactory reading is obtained.
- When current measurement has been completed, disconnect the connection between the testing leads and the circuit under test.
- When measuring 5A~10A: for continuous measurement ≤ 10 seconds and interval time between 2 measurement greater than 15 minutes.

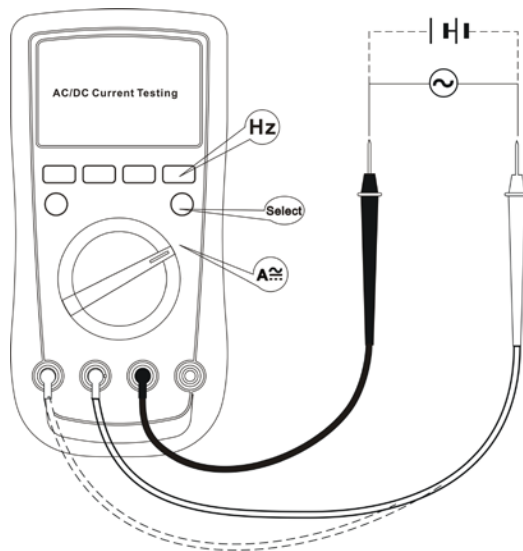

Figure 6

D. Resistance Testing (see figure 7)



Warning

To avoid damages to the Meter or to the devices under test, disconnect circuit power and discharge all the high-voltage capacitors before measuring resistance. To avoid harm to yourselves, never attempt to input an effective voltage over 60V in DC or 30V in AC.

To measure resistance, connect the Meter as follows:

1. Insert the red test lead into the Ω terminal and the black test lead into the **COM** terminal.
2. Set the rotary switch to an appropriate measurement position in Ω range then press **BLUE** button to select resistance measurement mode.
3. Connect the test leads across with the object being measured.
The measured value shows on the display.

Note

- When there is no input, for example in open circuit condition, the Meter displays “OL”.
- When the resistance reading $\geq 0.5\Omega$ in the short-circuit condition, please check for loose test leads or other reasons.
- For high resistance ($>1M\Omega$), it is normal taking several seconds to obtain a stable

reading, and it is better to choose shorter test lead.

- When resistance measurement has been completed, disconnect the connection between the testing leads and the circuit under test.

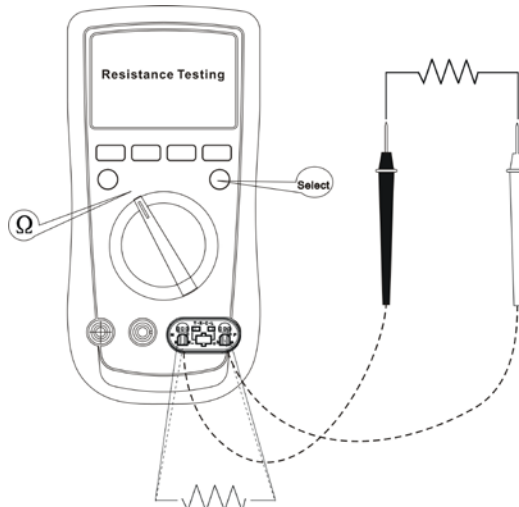

Figure 7

E. Continuity Testing (see figure 8)



Warning

To avoid possible damage to the Meter and to the device under test, disconnect circuit power and discharge all high-voltage capacitors before testing diodes and continuity.

To avoid harm to yourselves, never attempt to input an effective voltage over 60V in DC or 30V in AC.

To test for continuity, connect the Meter as below:

1. Insert the red test lead into the **••)** terminal and the black test lead into the **COM** terminal.
2. Set the rotary switch to **••)** , then press **BLUE** button to select continuity measurement mode.
3. Connect the test leads across with the object being measured.
 - The buzzer does not sound when the resistance value is $>30\Omega$. The circuit is disconnected.
 - The buzzer sounds continuously when the resistance value is $\leq 30\Omega$. The circuit is in

good condition.

4. The nearest value of the tested circuit show on the display, the unit is Ω .

Note

- Open-circuit voltage is approx. 3V.
- When continuity testing has been completed, disconnect the connection between the testing leads and the circuit under test.

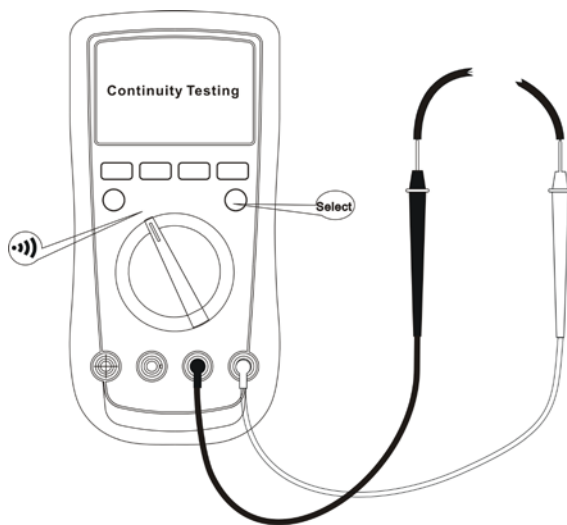

Figure 8

F. Diode Testing (see figure 9)





Warning

To avoid possible damage to the Meter and to the device under test, disconnect circuit power and discharge all high-voltage capacitors before testing diodes and continuity.

To avoid harm to yourselves, never attempt to input an effective voltage over 60V in DC or 30V in AC.

To test a diode out of a circuit, connect the Meter as follows:

1. Insert the red test lead into the  terminal and the black test lead into the **COM** terminal.
2. Set the rotary switch to .
3. For forward voltage drop readings on any semiconductor component, place the red test lead on the component's anode and place the black test lead on the component's cathode. The polarity of red test lead is "+" while black test lead is "-".
4. The measured value shows on the display.

Note

- In a circuit, a good diode should still produce a forward voltage drop reading of 0.5V to 0.8V; However, the reverse voltage drop reading can vary depending on the resistance of other pathways between the probe tips.
Connect the test leads to the proper terminals as said above to avoid error display.
- The LCD will display “OL” indicating open-circuit or wrong polarity connection.
- When diode testing has been completed, disconnect the connection between the testing leads and the circuit under test.

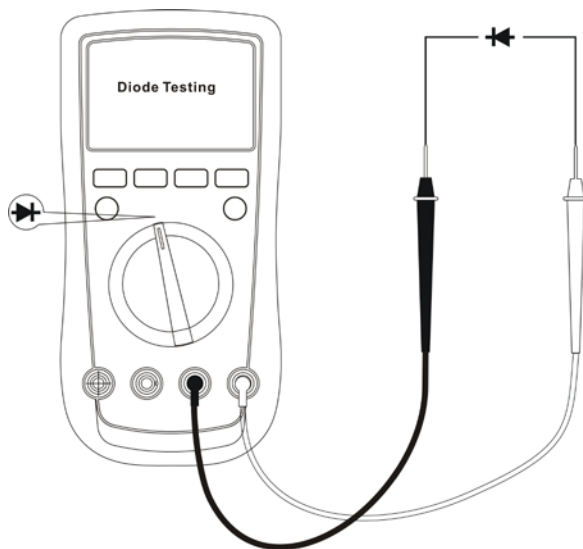

Figure 9

G. Capacitance Testing (see figure 10)



Warning

To avoid damage to the Meter or to the equipment under test, disconnect circuit power and discharge all high-voltage capacitors before measuring capacitance.

To measure capacitance, connect the Meter as follows:

1. Insert the red test lead into the **⎓** terminal and the black test lead into the **COM** terminal.
2. Set the rotary switch to **⎓** and press **BLUE** button to select capacitance measurement mode.
3. The measured value shows on the display.

Note

- The LCD displays **OL** indicating the tested capacitor is shorted or it exceeds the maximum range.
- When capacitance measurement has been completed, disconnect all the connection between multi-purpose socket, capacitor and the Meter.

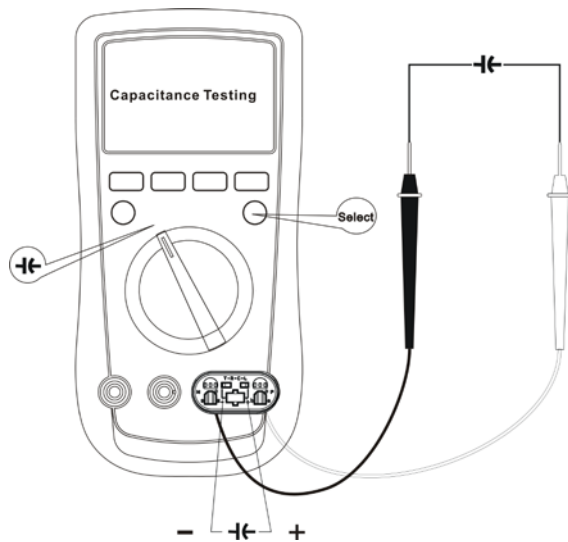

Figure 10

H. Frequency Testing (see figure 11)

To measure frequency, connect the Meter as follows:

1. Insert the red test lead into the **Hz** terminal and the black test lead into the **COM** terminal.
2. Under AC/DC voltage, DC millivoltage or AC/DC current measurement, press **Hz** button to select frequency measurement mode, the measured value shows on the display. Press **RANGE** to select next range, the maximum range is 1MHz.

Note

- Input Amplitude: Refer to accuracy specifications.
- When frequency measurement has been completed, disconnect the connection between the testing leads and the circuit under test, and remove the testing leads away from the input terminals of the Meter.

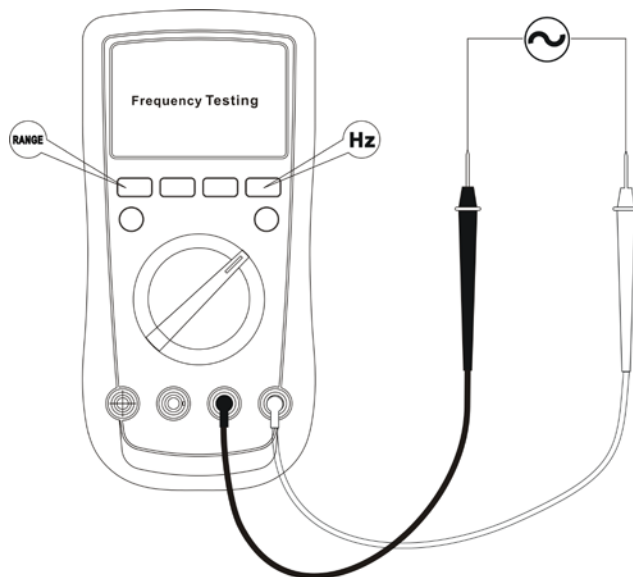

Figure 11

I. Temperature Measurement (UT109only)(See figure 12)



Warning

To avoid harm to yourself, do not input higher than DC 60V or AC 30V voltages.

To measure temperature, connect the Meter as follows:

1. Set the rotary switch to °C/°F. Press **BLUE** button to select temperature measurement mode.
2. Insert the temperature probe into the input terminal as shown on the figure 12.
3. Place the temperature probe to the object being measured.
After few seconds, the measured value shows on the display.
4. Press **BLUE** button to toggle between °C and °F temperature.

Note

- To avoid measurement error especially low temperature measurement, the operating temperature must not exceed 18 ~ 23°C.
- When temperature measurement has been completed, disconnect the connection between the temperature probe and the object being measured, and remove the temperature probe away from the input terminals of the Meter.

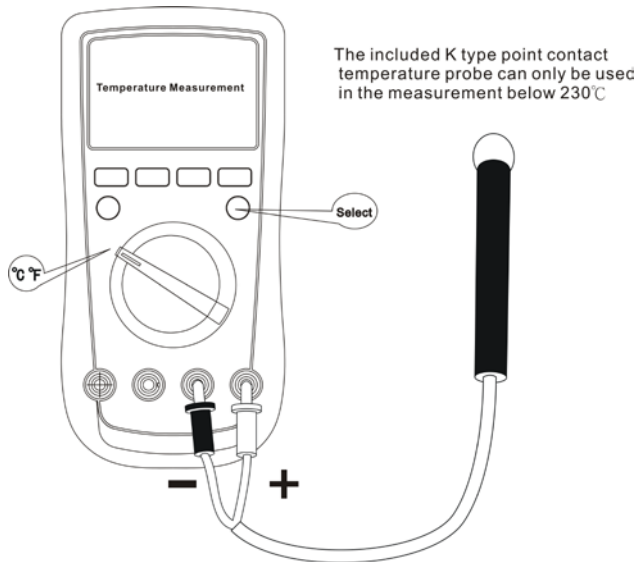

Figure 12

J. Dwell Testing (see figure 13)

It was very important in the past to test the dwell of the cut-off switch of an ignition system. The dwell testing means the duration when the cut-off switch remains off when the cam is turning. Now as an automobile is ignited electronically, it is no longer necessary to adjust the dwell. In addition, the dwell testing can also be used to test a mixed-controlled solenoid.

(e.g. GM feedback carburetor).

1. Set the rotary switch to **RPM X10 DWELL**. Press **RANGE** button to select the number of cylinders and press **BLUE** button to select **DWELL** measurement mode.
2. Insert the red test lead into the **V** terminal and the black test lead into the **COM** terminal. Connect the ends to be tested as illustrated.

If the cut-off switch of an ignition system is tested, connect the red test lead probe to the primary negative end of the ignition coil. (Refer to the automotive servicing manual for the specific position.)

If the dwell of an arbitrary ON/OFF equipment is tested, connect the red probe to the end of the equipment, fixed with an ON/OFF switch.

3. Connect the black test lead probe to the good ground terminal of the automobile.
4. Read the ignition dwell of the tested automobile directly from the display

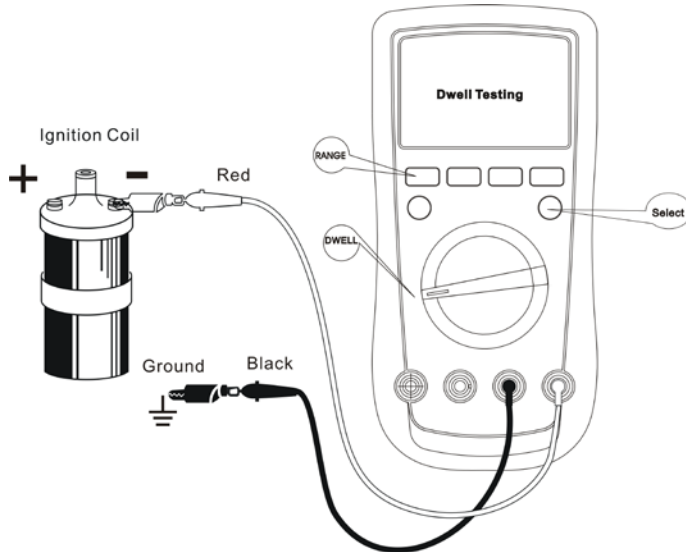

Figure 13

K. Engine Tach (Rotation Speed) Testing “RPMx10” (see figure 14)

The RPM means the rotating frequency of the main shaft of the engine per minute.

1. Set the rotary switch to **RPM X10 DWELL**. Press **RANGE** button to select the number of cylinders and press **BLUE** button to select **RPM X10** measurement mode.
2. Insert the red test lead into the **V** terminal and the black one into the **COM** terminal. Select an appropriate number of cylinders. Connect the ends to be tested as illustrated.
 - If a DIS ignition system without any distributor board is used in the automobile, connect the red test lead probe to the TACH (tachometer) signal line (which is connected to the computer DIS module of the automotive engine). Refer to the automotive servicing manual for the specific position.
 - If an ignition system with a distributor board is used in the automobile, connect the red test lead probe to the primary negative end of the ignition coil. (Refer to the automotive servicing manual for the specific position.)
3. Connect the black test lead probe to the good ground terminal of the automobile.
4. Upon the start of the engine or during its operation, test the rotation speed of the engine and read the displayed value from the display. The actual rotation speed of the automobile to be tested should be equal to the displayed value multiplied by 10. For example, the actual rotation speed of the engine of the automobile should be 2000

RPM (200 x 10) if the displayed value is 200 and the meter is set at the 6CYL (6 cylinders) notch.

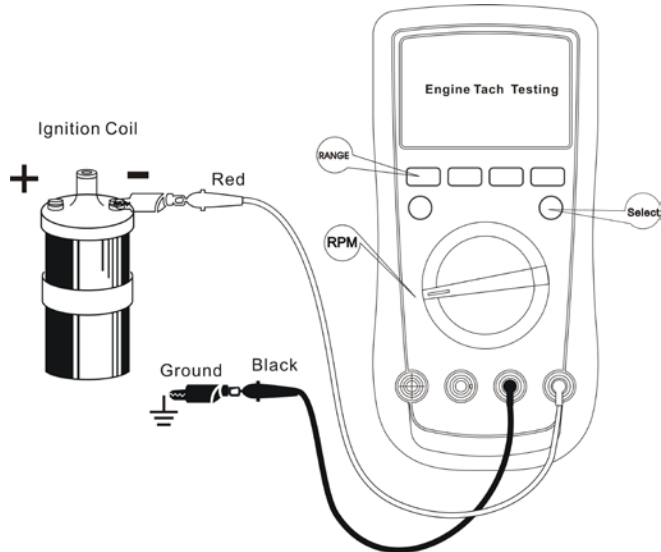

Figure 14

L. Operation of Hold Mode

The Hold mode is applicable to all measurement functions:

- Press **HOLD** to enter Hold mode
- Press **HOLD** again to exit Hold mode
- In Hold mode, **H** is displayed

M. RANGE button

- Press **RANGE** to enter the manual ranging mode; the Meter beeps.
- Press **RANGE** to step through the ranges available for the selected function; the Meter beeps.
- Press and hold **RANGE** for over 2 seconds to return to auto ranging.

N. MAX MIN button

- Press **MAX/ MIN** to start recording of maximum and minimum values. Steps the display through high (MAX) and low (MIN) readings. The Meter enters manual ranging mode after pressing **MAX / MIN** button.
- Press and hold MAX MIN for over 2 seconds to exit MAX MIN mode and return to the

present measurement range.

O. Data Outputting

- Press and hold Hz button for over 2 seconds to enter or exit RS232C or USB mode.
- The sleep mode feature will be disabled after entering RS232C or USB mode.

P. Display backlight

Press and HOLD button for over 2 seconds to turn on or turn off the display backlight.

Q. The BLUE button

It uses for selecting the required measurement function when there is more than one function at one position of the rotary switch.

R. Automatic power off

The meter power off automatically if you have not changed the rotary switch or pressed a button for 15 minutes.

Part 2 Diagnosis of Automotive Troubles

The Meter is a tool for the very effective diagnosis of the troubles with the electronic systems of the automobile. This part gives a special introduction as to how the Meter is used to diagnose any trouble with a fuse, switch, solenoid, relay, starting and charging systems, ignition system, fuel system and engine sensor.

A. Fuse Testing: Check the fuse to see if it is blown out.

1. Set the rotary switch to Ω .
2. Insert the red test lead into the Ω terminal and the black one into the **COM** terminal.
3. Short circuit the red and black test lead probes, when the reading of the meter should be displayed between 0.2Ω and 0.5Ω . If it is more than 0.5Ω , check the test leads to see whether they are well connected.
4. Connect the red and black test lead probes in parallel to the two ends of the fuse, when the reading of the meter should be displayed less than 10Ω , indicating that the fuse is good. When the display is overload "**OL**", it is shown that the fuse has been blown out.



Warning:

It must be replaced with a fuse of the same type and size.

B. Switch Testing: Check the switch to see if it can work correctly.

1. The same as in Items 1 to 3 (Fuse Testing).
2. Connect the black test lead probe to one end of the switch and the red one to another end. When the switch is connected, the reading of the meter should be displayed less than 10 Ω . When the switch is cut off, overload “OL” should be displayed as the reading of the meter.

C. Solenoid or Relay Testing

1. The same as in Items 1 to 3 (Fuse Testing).
2. Connect the red and black test lead probes in parallel to the two end of a solenoid or relay. The impedance of most of solenoids or relay coils is less than 200 Ω . (See the details in the automotive manual.)



Warning:

Both ends of a general solenoid or relay are connected with diodes.

Check to see if there is any damaged coil. Even if the coil is found satisfactory, the solenoid or relay may still be damaged. The relay may be welded or worn due to the frequent sparking of the contacts. The solenoid may be stuck when the coil is in an on-position. Therefore some potential problems cannot be found in testing.

D. Starting/Charging System Testing

The on-off package of the engine starting system consists of a battery, engine starting button, solenoid and relay starting buttons, lead connections and lines. During the operation of the engine, the charging system keeps the battery charged. This system consists of an AC generator, voltage calibrator, lead connections and circuits. The multimeter is an effective tool for the checking of these systems.

1. Load-Free Battery Testing

Before testing the starting/charging system, test the battery to see if it is fully charged.

- (1) Set the rotary switch to DCV.
- (2) Insert the red test lead into the V terminal and the black one into the COM terminal.
- (3) Turn off the ignition switch.
- (4) Turn on the driving lights for 10 sec. to release charges from the battery.
- (5) Connect the black test lead probe to the negative pole of the battery and the red one to the positive pole of the battery.

2. The testing results are shown in contrast as follows and if the battery is less than 100%, please use it after charging it.

12.60 V	100%
12.45 V	75%
12.30 V	50%
12.15 V	25%

E. Battery Power Consumption Testing when the Engine is off

The test is carried out to find the amperage of the power consumption of the battery when both the ignition key and the engine are off. The test is helpful for the determination of the additional consumption of the battery, which may finally lead to the exhaustion of the battery.

1. Turn off and close the ignition key and all its accessories.

Make sure that the bus, engine louver and room lights have been turned off and closed.

2. Set the rotary switch to **A 10A**.

Insert the red test lead into the A terminal and the black one into the **COM** terminal.

3. Cut off the link between the positive pole of the battery and the cable and connect the test lead probes to the circuit. (Connect the red test lead probe to the positive pole of the battery and the black one to the negative pole of the battery.)



Warning:

Do not start the engine of the automobile in testing, or the meter will be damaged.

4. Read the reading of the tested current directly from the display with the normal current being about 100mA. For the special supply of currents (when the engine is off), please refer to the automotive servicing manual. If there emerges any additional current, do necessary servicing.



Warning:

A frequency-modulated radio or clock needs a current supply of 100 mA.

F. Trigger Voltage Battery Load Testing

Upon the start of the engine, test the battery to see if it can offer an adequate voltage.

1. Set the rotary switch to **DCV**.
2. Insert the red test lead into the **V** terminal and the black one into the **COM** terminal.
3. Interrupt the ignition system to disable the start of the automobile.
Cut off the main ignition coil, shunt coil, cam and starting sensor so as to interrupt the ignition system. Operate according to the automotive manual.
4. Connect the black test lead probe to the negative pole of the battery and the red one to

the positive pole of the battery.

5. Start the engine continuously for 15 seconds and the testing results are shown in contrast as follows. If it is within the range, the starting system is normal; on the contrary, it is shown that there may be something wrong with the battery cable, starting system cable, starting solenoid or starting motor

Voltage	Temperature
9.6 V or more	21.1°C (70°F)
9.5 V	15.6°C (60°F)
9.4 V	10.0°C (50°F)
9.3 V	4.4°C (40°F)
9.1 V	-1.1°C (30°F)
8.9 V	-6.7°C (20°F)
8.7 V	-12.2°C (10°F)
8.5 V	-17.8°C (0°F)

G. Voltage Drop Testing

Test the voltage drops caused by the switch, cable, solenoid or connector. Any abnormal voltage drop generally results from an additional resistance. The resistance will restrict the currents upon the start of the engine, leading to the reduction of the load voltage of the battery and the slow-down of the start of the engine.

1. Cut off the ignition system so as to disable the start of the automobile.
Cut off the main ignition coil, shunt coil, cam and starting sensor so as to cut off the ignition system. Operate by reference to the automotive manual.
2. Set the rotary switch to **DCmV** or **DCV**. Insert the red test lead into the **A** terminal and the black test lead into the **COM** terminal.
3. Refer to the LOSS typical trigger voltage circuit. (See figure 15)

Test the voltage between any of the following pairs of points respectively:

1&2, 2&3, 4&5, 5&6, 6&7, 7&8, 8&9, 8&10

Component	Voltage
Switch	300 mV
Lead	200 mV
Grounding	100 mV
Battery Lead Connector	50 mV
Wiring	0.0 V

Compare the readings of the tested voltages against the said table. If the voltage is on the high side, check the components and connectors to see if there is anything wrong. If anything wrong is found, do necessary servicing.

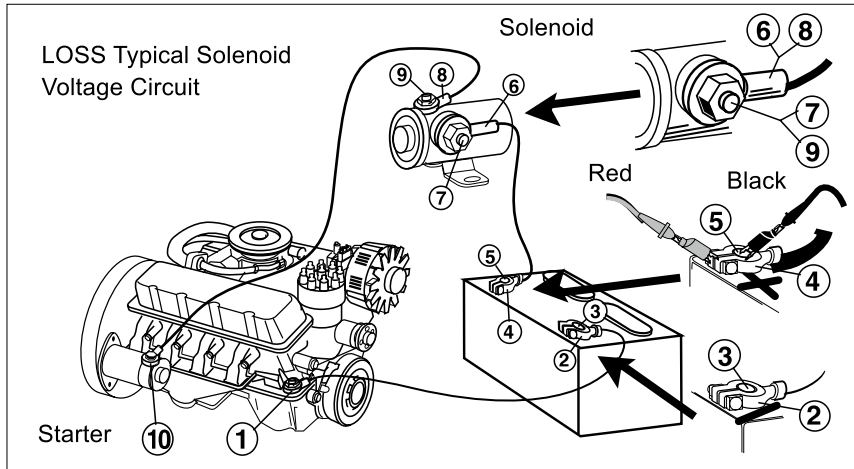

Figure 15

H. Charging System Voltage Testing

This testing is used to see if the charging system operates normally so as to provide the electronic systems with adequate power (lamps, electric fans, radio sets, etc.).

1. Set the rotary switch to the **DCV**. Insert the red test lead into the **A** terminal and the black one into the **COM** terminal.
2. Connect the black test lead probe to the negative pole of the battery and the red one to the positive pole of the battery.
3. Run the engine idle and close or turn off all the accessories with the normal voltage readings being 13.2 V to 15.2 V.
4. Open the throttle and control the rotation speed of the engine between 1800 RPM and 2800 RPM. The voltage readings should be consistent with those in (3) (with the difference being no more than 0.5 V).
5. Turn on the lamps, windshield wipers, fans and so on to increase the loads of the electronic systems with the voltage readings being no less than 13.0 V.
6. If the readings in Steps 3. 4. and 5. are normal, the charging system is also normal. If the readings in Steps 3. 4. and 5 are beyond the limits or inconsistent with those in the operation manual, check the current ranges of the conveying belt, regulator, AC generator, connector and open-circuit AC generator. If any further diagnosis is required, refer to various kinds of automotive manuals.

I. Ignition System Testing

1. Ignition Coil Testing

- (1) Before the operation, cool the engine and cut off the ignition coil.
- (2) Set the rotary switch to the Ω . Insert the red test lead into the Ω terminal and the black one into the **COM** terminal. Test the primary coil of the ignition coil.
- (3) Short circuit the red and black test lead probes. Their short circuit resistance should be less than 0.5Ω . If it is more, check the test lead to see if it is loose or damaged. If it is damaged, replace it with a new one.
- (4) Connect the red test lead probe to the primary "+" pole of the ignition coil and the black one to the primary "-" pole of the coil. (see figure 16.) See the detailed positions in various kinds of automotive manuals.



Warning:

The reading of the testing becomes the actual tested resistance only after the reduction of the short-circuit values of the test leads.

The primary resistance is generally between 0.3Ω and 2.0Ω .

- (5) Set the rotary switch to the $200 \text{ k}\Omega$ and test the primary coil of the ignition coil.
- (6) Connect the red test lead probe to the secondary outlet and the black one to the primary "-" pole. Refer to various kinds of automotive manuals for the details.

- (7) The primary resistance is generally in a range of 6 k Ω to 30 k Ω . Refer to various kinds of automotive manuals for the details.
- (8) For a heater ignition coil, repeat the said testing steps.



Warning:

For a heater ignition coil, the resistance may be a little higher because the resistance of a coil will vary with the temperatures. The higher the temperature, the resistance will be higher; on the contrary, it will become lower.

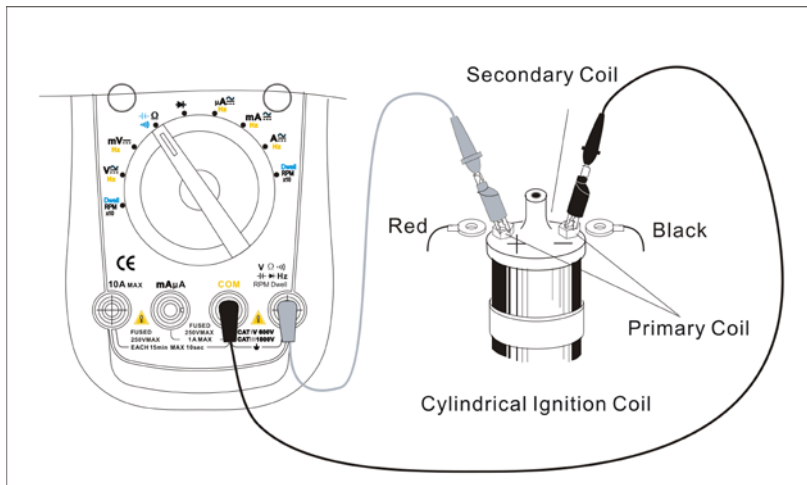

Figure 16

2. Ignition System High-Voltage Damper Testing (see figure 17)

- (1) Move the connectors of the ignition system from the engine. Refer to the ignition system movement procedure in various kinds of automotive manuals for the details.



Warning:

Some of Chrysler's products use a spark plug high voltage damper with "positive lock" end electrodes, which can only be moved out of the distributor board. If it is moved out of anywhere else, some damage will result. Refer to various kinds of automotive manuals for the details.

- (2) Set the rotary switch to the Ω . Insert the red test lead into the Ω terminal and the black one into the **COM** terminal.
- (3) Connect the red and black test lead probes in parallel to the two ends of the high-voltage damper and observe the reading. The normal resistance is generally in a range of 3 k Ω to 50 k Ω . In bending the lead, the reading should remain unchanged.

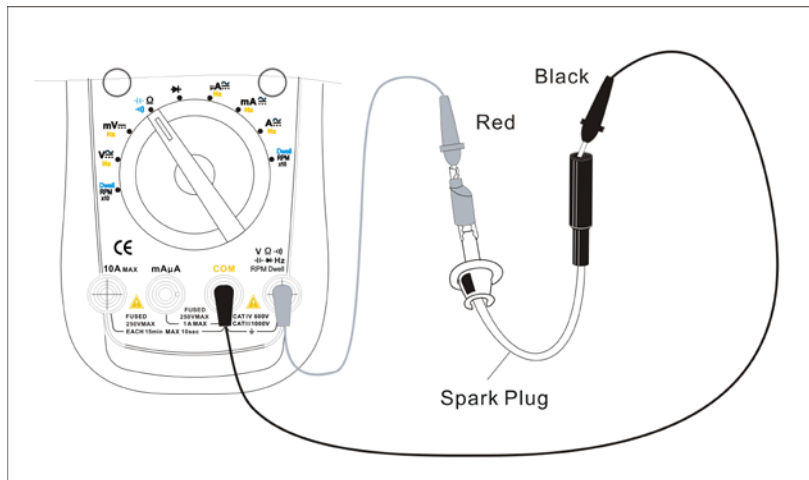

Figure 17

3. Hall Switch/Sensor Testing (see figure 18)

When the tach and dwell are tested in the computer of the automobile, a Hall sensor is used. The Hall sensor is normally used in the ignition system to detect the position of the camshaft so that the computer of the automobile can set the optimal time for the ignition and the opening of the fuel injector.

- (1) Move the Hall sensor out of the automobile and see the details of the operation in various kinds of automotive manuals.
- (2) Connect the positive pole of the 9 V battery to the source end of the sensor and the negative pole to the ground end of the sensor by referring the details to the positions of the source and ground ends of the sensor in various kinds of automotive manuals.
- (3) Set the rotary switch of the meter to Ω . Insert the red test lead into the Ω terminal and the black one into the **COM** terminal.
- (4) Connect the red and black test lead probes in parallel to the signal connect terminal and ground end of the sensor and the meter should display a small ohm.
- (5) When a metal plate (blade, steel tape, etc.) is inserted into a concave magnetic pole of the sensor, the display of the meter will be enlarged or overloaded; if the metal plate is moved away, the display will become smaller, which proves that the sensor is satisfactory.

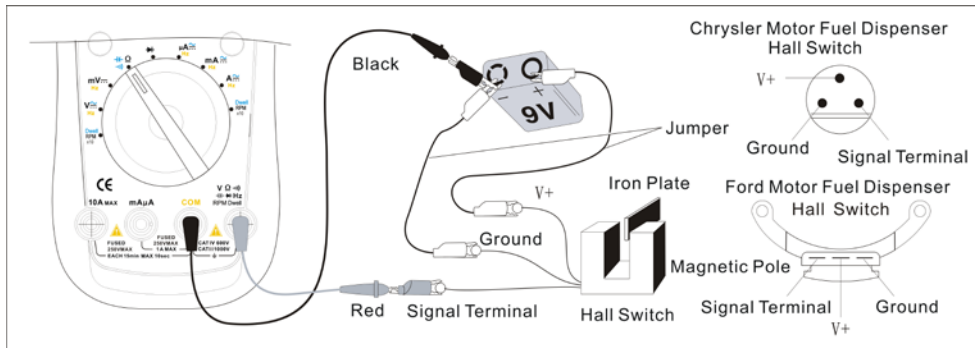

Figure 18

4. Magnetic Resistance Sensor (see figure 19)

The functions of a magnetic resistance sensor is similar to those of a Hall sensor and the testing methods of both sensors are also similar. Their normal resistance is generally in a range of $150\ \Omega$ to $1\ \text{k}\Omega$. Refer to the ranges of resistance in various kinds of automotive manuals for the details.

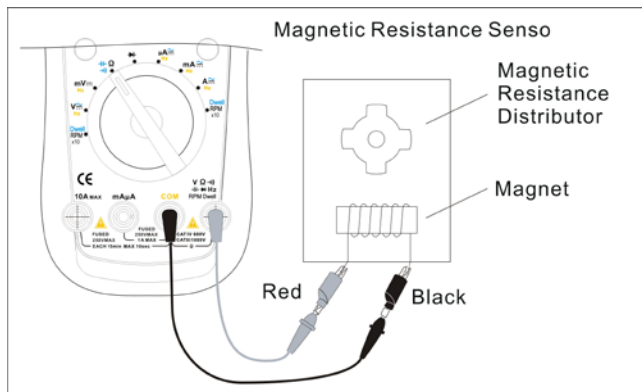

Figure 19)

5. RPM Testing (see figure 20)

- (1) Set the rotary switch to RPMx10 and select the number of cylinders in the automobile to be tested.
- (2) Insert the red test lead into the terminal and the black one into the COM terminal.
- (3) Connect the black test lead probe to the ground (i.e. ground strap connection) of the automobile and the red one to the appropriate testing test terminal of the computer of the automobile if the automobile is in a DIS type (Refer to the servicing handbooks of various kinds of automotive manuals for the detailed position); or the negative pole of the ignition coil if the automobile is equipped with a distributor board (Refer to the servicing handbooks of various kinds of automotive manuals for the detailed position).
- (4) The normal starting rotation speed of an engine is about 50 RPM to 275 RPM. Refer the detailed position to the servicing handbooks of various kinds of automotive manuals because this value relates to the then temperature, engine size, battery size, etc..



Warning:

The displayed value of the meter becomes the actual tach reading only after it is multiplied by 10.

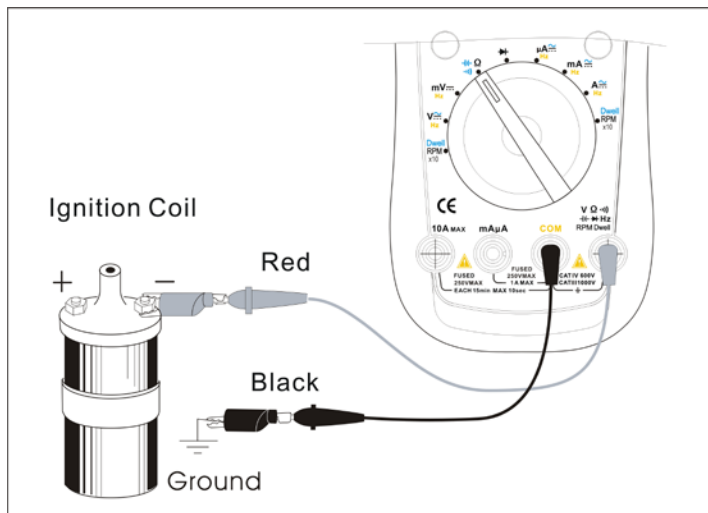

Figure 20

6. Fuel System Testing

It is necessary to add more accurate engine fuel control to a low injection automobile. Since 1980, the automotive manufacturing industry has used electronically-controlled carburetor and fuel injection so as to achieve lower fuel injection.

(1) GM (General Motor): Testing the dwell of the C-3 mixed-control solenoid: Place the solenoid in a cylinder, monitoring the ratio between the air and the fuel, which should generally be 14.7 to 1 between the air and the fuel so as to reduce the injection of surplus fuel. The testing is used to see if the solenoid is installed right in the position and the dwell of the meter can also indirectly used for the testing.

[1] Start the engine of the automobile to achieve a rotation speed of 3000 RPM.

So far as a GM automobile is concerned, set the rotary switch to the DWELL and select 6CYL.

[2] When the automobile is operating in a short fuel state or in a long fuel state, the dwell of the meter should be displayed between 10° and 50°.

(2) Fuel Injector Resistance Testing (see figure 21)

The testing method is similar to that of the resistance of an ignition coil.

[1] Cut the electric link off the injector. (Refer to the servicing handbooks of various kinds of automotive manuals for the detailed position.)

[2] Connect the red and black test lead probes to the two ends of the injector. The

general normal resistance is less than or equal to 10 Ω .

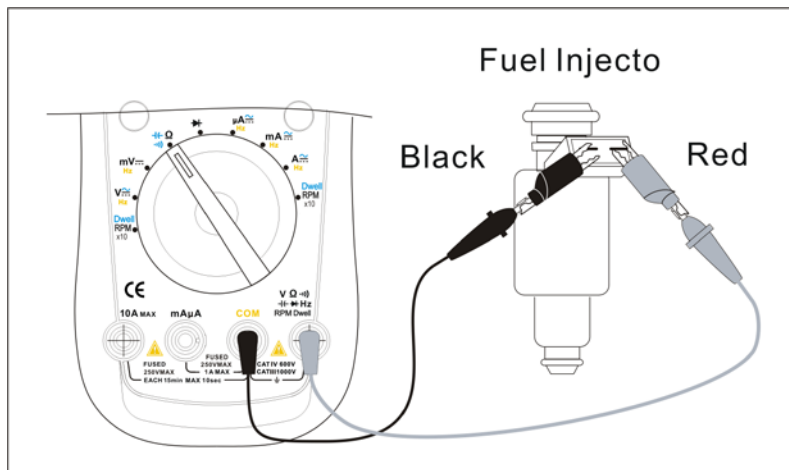

Figure 21

J.Engine Sensor Testing (see figure 22)

To be adapted to the provisions for low injection and fuel saving in the early period of the eighties, the computer-controlled regulators were installed in the automobile and the sensors provided the computer with some data required. The Meter is an effective tool for the detection of the operation of a sensor.

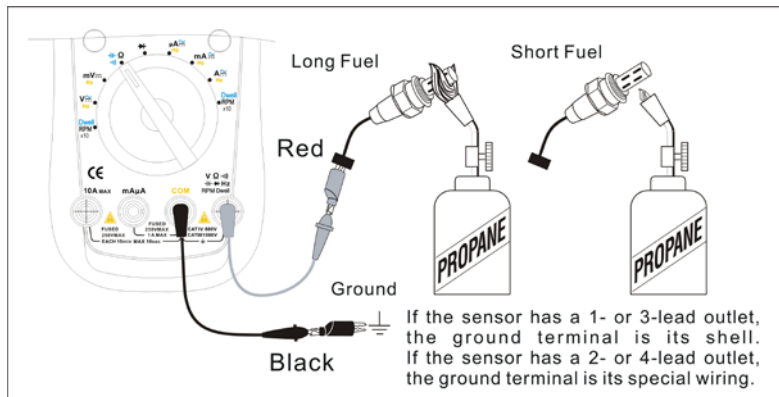

Figure 22

1. Oxygen Sensor

The oxygen sensor is used to test the oxygen content in the exhaust, giving rise to an appropriate voltage or resistance. A low voltage (high resistance) means too high oxygen content in the exhaust, while a high voltage (low resistance) means too low oxygen content. The computer regulates the ratio between the air and the fuel according to the high or low voltage. There are normally two types of oxygen sensors: the zirconia and titania sensors. (Refer to the different external properties of the two types for the details.)

Testing Procedure:

- (1) Move the oxygen sensor out of the automobile.
- (2) Set the rotary switch to Ω . Insert the red test lead into the Ω terminal and the black one into the **COM** terminal.
- (3) Connect the black test lead probe of the meter to the ground terminal (i.e. cold end) of the sensor.



Warning:

If the sensor has a 1- or 3-lead outlet, the ground terminal is its shell.

If the sensor has a 2- or 4-lead outlet, the ground terminal is its special wiring.

- (4) Connect the red test lead probe of the meter to the signal terminal (i.e. hot end) of the sensor.

If the sensor has more than 3 leads, what is used in the automobile is a heat oxygen sensor, which has 2 hot ends. Refer the positions of the hot ends in various kinds of automotive manuals. At this time, connect the red and black test lead probes respectively to these two hot ends. Compare the readings with the specifications in the operation manual provided by the manufacturer.

The ZIRCONIA sensor is tested with the **DCV**. Insert the red test lead into the **V** terminal and insert the black test lead into the **COM** terminal.

The TITANIA sensor is tested with the **Ω**. Insert the red test lead into the **Ω** terminal and insert the black test lead into the **COM** terminal.

Secure the sensor with a table vice, light up the propane burner and add a heat sensor terminal. Make its temperature about 660 °F and exhaust the oxygen from the sensor, when the readings can be obtained:

The ZIRCONIA sensor has a voltage of 0.6 V or more.

The TITANIA sensor has a resistance of about 1 Ω.

Move the burner away for heating, when the reading can be obtained:

The ZIRCONIA sensor has a voltage of 0.4 V or more.

The TITANIA sensor has a resistance of about 4 kΩ.



Warning:

In testing, the readings will vary with the heating temperature.

2. Temperature Sensor (see figure 23)

The temperature sensor changes the output resistance through the changes in peripheral temperatures. The hotter the sensor is, the lower the resistance becomes. The temperature sensor is generally used in engine braking, air ventilation, flow, fuel temperature and other equipment.

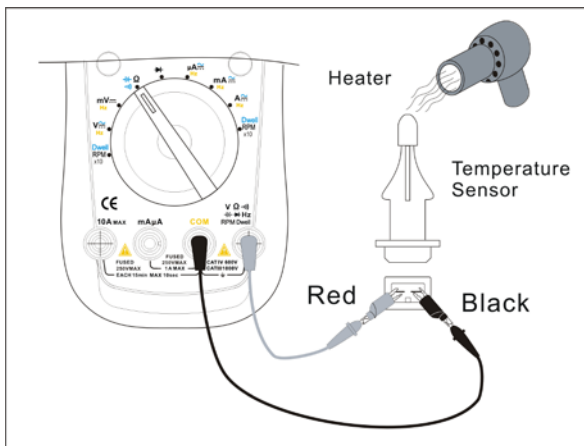

Figure 23

Testing Procedure:

- (1) The same as in the resistance testing method.
- (2) When the general temperature of a heating sensor rises, its resistance will drop. The thermal resistance of the temperature sensor of the automotive engine is generally less than 300 z.

3. Position Sensor (see figure 24)

The position sensor is an electrometer or variable resistance. It is used for the computer monitoring of the position and direction of a mechanical device. The typical position sensors include throttle, exhaust recalculating EGR, blade air flow and other sensors.

Testing Procedure:

- (1) The same as in the resistance testing method.
- (2) Connect the red and black test lead probes respectively to the signal test terminal and ground terminal. Refer to various kinds of automotive servicing manuals for its position and the resistance to be tested.

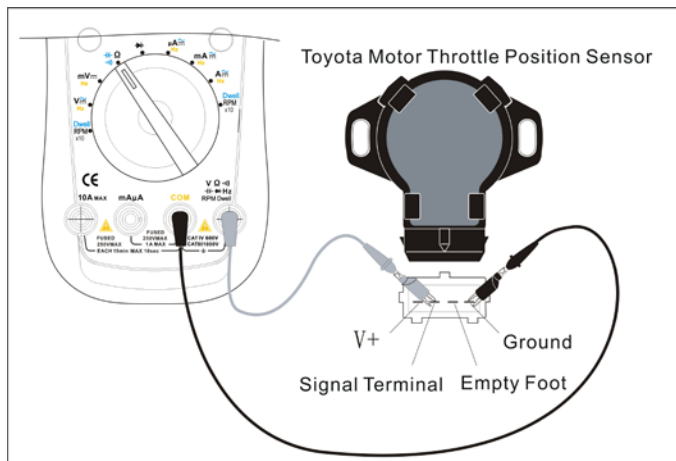

Figure 24

4. Absolute Pressure (MAP) and Baro Sensor (see figure 25)

The MAP sensor is used to change a pressure signal into a DC voltage or frequency one. All GM, Chrysler, Honda and Toyota use DC voltage type MAP sensors, while Ford uses frequency type MAP sensors. Refer to relevant manuals for other automotive manufacturers.

Testing Procedure:

- (1) Connect the DC voltage type MAP sensor in the DC voltage testing method and set the rotary switch to **DCV**.
- (2) Connect the frequency type MAP sensor in the RPMx10 testing method and set the meter to the number of cylinders in the automobile.
- (3) Taking 4 cylinders (4CYL) for example, connect the black test lead probe of the meter to the ground terminal (i.e. ground strap connection) and connect the red one as illustrated in figure 25.
- (4) Turn on the ignition key but do not start the engine.

Displayed Values:

DC Voltage Type Sensor: In a vacuum state, the displayed value is generally between 3 V and 5 V. (The details shall be based on the parameters furnished by the supplier.)

Frequency Type Sensor: In a vacuum state, the displayed value is generally 4770 RPM $\pm 5\%$. (This only applies to the MAP sensor produced by Ford and the other sensors shall

be based on the parameters furnished by the supplier.)



Warning:

$\text{RPM} = \text{Frequency} \times 120 / \text{the number of cylinders.}$

UT108/109 OPERATING MANUAL

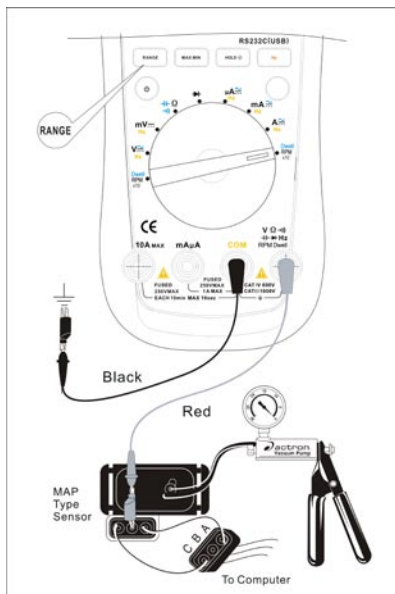

Figure 25

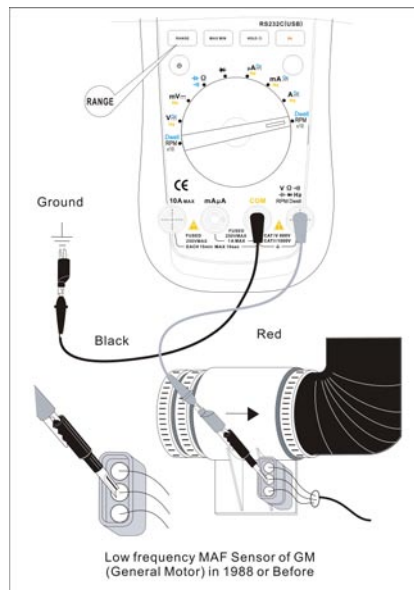

Figure 26

5. Mass Air Flow (MAF) Sensor (see figure 26)

The sensor converts the air flow into a DC voltage, low frequency or high frequency signal. The Meter can only be used to test a DC voltage or low frequency signal.

Testing Procedure:

- (1) Connect the DC voltage type MAF sensor in the DC voltage testing method and set the rotary switch to DCV. Connect the frequency type MAF sensor in the RPM testing method and set the meter to the number of cylinders in the automobile. Now take 4 cylinders (4CYL) for example.
- (2) Connect the black test lead probe of the meter to the ground terminal (i.e. ground strap connection) and connect the red one as illustrated in figure 25.
- (3) Turn on the ignition key but do not start the engine.

Displayed Values:

DC Voltage Type Sensor: The displayed value should be less than or equal to 1V. (The details shall be based on the parameters furnished by the supplier.)

Frequency Type Sensor: In a vacuum state, the displayed value should be 330 RPM±5%. (This only applies to GM low frequency sensors.) The other low frequency sensors shall be based on the parameters furnished by the supplier.)



Warning:

$\text{RPM} = \text{Frequency} \times 120 / \text{the number of cylinders.}$

General Specifications

- Maximum Voltage between any Terminals and grounding: Refer to different range input protection voltage.
- Fuse Protection of μA mA terminal: 1A, H 240V, fast type, $\phi 6 \times 25\text{mm}$
- Fuse Protection of A terminal: 10A, H 240V, fast type, $\phi 6 \times 25\text{mm}$
- Maximum Display: 4000. analogue bar graph 41 segments
- Measurement Speed: Updates 2-3 times /second.
- Range: Auto or manual
- Polarity Display: Auto
- Overload Display: **OL**
- Battery Deficiency: Display  .
- Temperature:
 - Operating: $0^{\circ}\text{C} \sim 40^{\circ}\text{C}$ ($32^{\circ}\text{C} \sim 104^{\circ}\text{C}$).
 - Storage: $-10^{\circ}\text{C} \sim 50^{\circ}\text{C}$ ($14^{\circ}\text{F} \sim 122^{\circ}\text{F}$).
- Relative Humidity: $\leq 75\%$ @ 0°C to below 30°C ;
 $\leq 50\%$ @ 30°C to 40°C .
- Altitude:
 - Operating : 2000m;
 - Storage: 10000m.

- Electromagnetic Compatibility: EN61326-1:2006, EN61326-2:2006
- Battery Type: One piece of 9V (NEDA1604 or 6F22 or 006P).
- Dimensions (HxWxL): 180 x 87 x 47mm.
- Weight: 370g. (including holster and battery)
- Safety/Compliances:
IEC61010: CATIII 1000V, CATIV 600V overvoltage and double insulation standard.
- Certification: **CE**

Accurate Specifications

Accuracy: \pm (a% Reading + Digits), guarantee for 1 year.

Operating Temperature: 18°C to 28°C.

Relative Humidity: No more than 75% RH.

A. DC Voltage

Range	Resolution	Accuracy	Overload Protection	Input impedance
4V	1 mV	\pm (0.5%+3)	1000V DC/AC	Around 10M Ω
40V	10 mV			
400V	100 mV			
1000V	1 V			

B. AC Voltage

Range	Resolution	Accuracy(40Hz ~ 400Hz)	Accuracy (400Hz ~ 1kHz)
4V	1mV	\pm (1%+3)	\pm (2%+3)
40V	10mV		
400V	100mV		
1000V	1V	\pm (1.2%+5)	\pm (2%+5)

Remarks:

- Input impedance: Around 10MΩ.
- Overload Protection: 1000V DC or AC
- Displays effective value of sine wave (mean value response)(10%~100% of the range)

C. DC millivoltage

Range	Resolution	Accuracy	Overload Protection	Input impedance
40mV	0.01 mV	± (0.8%+3)	500AC	Around 4000MΩ
400mV	0.1 mV			

D. DC Current

Range	Resolution	Accuracy	Overload Protection
400μA	0.1μA	± (1%+2)	Fuse 1A, H 240V, fast type, φ6x25mm
4000μA	1μA		
40mA	10μA	± (1.2%+3)	
400mA	100μA		
4A	1mA	±(1.5%+3)	Fuse 10A, H 240V, fast type, φ6x25mm
10A	10 mA		

Remarks:

- When measuring 5 to 10A:
For continuous measurement ≤ 10 seconds and interval time between 2 measurement greater than 15 minutes.

E. AC Current

Range	Resolution	Accuracy(40Hz ~ 400Hz)	Accuracy(400Hz ~ 1kHz)
400 μ A	0.1 μ A	$\pm (1.2\%+5)$	$\pm (1.2\%+10)$
4000 μ A	1 μ A		
40mA	10 μ A	$\pm (1.5\%+5)$	$\pm (1.5\%+10)$
400mA	100 μ A		
4A	1mA	$\pm (2\%+5)$	$\pm (2\%+10)$
10A	10mA		

Remarks:

- Fuse Protection of μ A mA terminal: 1A, H 240V, fast type, $\phi 6 \times 25$ mm
- Fuse Protection of A terminal: 10A, H 240V, fast type, $\phi 6 \times 25$ mm
- Displays effective value of sine wave (TRMS)(10%~100% of the range)
- When measuring 5 to 10A:

For continuous measurement ≤ 10 seconds and interval time between 2 measurement greater than 15 minutes.

F. Resistance

Range	Resolution	Accuracy	Overload Protection
400 Ω	0.1 Ω	$\pm (1\%+5)$	500Vp
4k Ω	1 Ω		
40k Ω	10 Ω		
400k Ω	100 Ω		
4M Ω	1k Ω		
40M Ω	10k Ω	$\pm (1.5\%+5)$	

G. Capacitance

Range	Resolution	Accuracy	Overload Protection
10nF	10pF	$\pm(3\%+5)$	500Vp
100nF	100pF		
1000nF	1nF		
10 μ F	10nF		
100 μ F	100nF		

H. Frequency

Range	Accuracy
10Hz~1MHz	$\pm (0.1\%+4)$

Overload Protection: the same as AC/DC voltage, DC millivoltage, AC/DC Current, and RPM mode.

Input Amplitude: a

1) AC/DC voltage mode,

When 40Hz ~ 1KHz: $a \geq \text{range} \times 10\%$ (except 1000V range)
 $a \geq 400\text{V}$ (1000V range)

When 10Hz ~40Hz or 1k Hz ~1MHz: for refer only.

2) AC/DC Current mode,

When 40Hz ~ 1KHz: $a \geq \text{range} \times 10\%$ (except 10 A range)
 $a \geq 4\text{A}$ (10 A range)

When 10Hz ~40Hz or 1k Hz ~1MHz: for refer only.

3) DC millivoltage mode,

When $\leq 100\text{KHz}$: $40\text{mV} \leq a \leq 200\text{V rms}$

When 10Hz ~1MHz ~1MHz: $200\text{mV} \leq a \leq 10\text{V rms}$

I. Diode

Range	Resolution	Overload Protection
→	1mV	500Vp

Remarks:

- Open circuit voltage approximate 3V.
- The silicon PN junction normal voltage is about 500 mV to 800 mV.

J. Continuity Testing

Range	Resolution	Overload Protection
••)	0.1Ω	500Vp

Remarks:

- Open circuit voltage approximate 3V.
- The buzzer does not sound when the resistance value is $>30\Omega$. The circuit is disconnected.
- The buzzer sounds continuously when the resistance value is $\leq 30\Omega$. The circuit is in good condition.

K.Dwell Testing

Range	Resolution	Accuracy	Overload Protection
4CYL	0.1°	± (3%+5)	500 Vp
6CYL			
8CYL			

Remark:

- Input Scope:
≥10V in forward impulse;
Bandwidth ≥ 0.5mS

L. Tach (Rotation Speed) Testing

Range	Resolution	Accuracy	Overload Protection
4CYL	10 RPM	± (3%+5)	500 Vp
6CYL			
8CYL			

Remarks:

- Input Scope:
≥10V in forward impulse;

Bandwidth $\geq 0.5\text{mS}$

- Maximum Tach: 10000 RPM, Tach = Displayed Reading x 10.

M. Temperature (UT109 only)

Range	Resolution	Accuracy	Overload Protection
-400C ~ 537°C	1°C	$\pm(1\%+10)$	500 Vp
-400F ~ 998°F	2°F	$\pm(1\%+18)$	

Maintenance

This section provides basic maintenance information including battery and fuse replacement instruction.



Warning

Do not attempt to repair or service your Meter unless you are qualified to do so and have the relevant calibration, performance test, and service information.
To avoid electrical shock or damage to the Meter, do not get water inside the case.

A. General Service

- Periodically wipe the case with a damp cloth and mild detergent. Do not use abrasives or solvents.
- To clean the terminals with cotton bar with detergent, as dirt or moisture in the terminals can affect readings.
- Turn the Meter off when it is not in use and take out the battery when not using for a long time.
- Do not store the Meter in a place of humidity, high temperature, explosive, inflammable and strong magnetic field.

B. Replacing the Fuses (see figure 27)



Warning

To avoid electrical shock or arc blast, or personal injury or damage to the Meter, use specified fuses **ONLY** in accordance with the following procedure.

To replace the Meter's fused:

1. Turn the Meter off and remove all connections from the terminals.
2. Remove the holster from the Meter.
3. Remove the 3 screws from the case bottom, and separate the case top from the case bottom.
4. Remove the fuse by gently prying one end loose, then take out the fuse from its bracket.
5. Install **ONLY** replacement fuses with the identical type and specification as follows and make sure the fuse is fixed firmly in the bracket.

Fuse 1: 1A, H 240V, fast type, $\phi 6 \times 25$ mm.

Fuse 2: 10A, H 240V, fast type, $\phi 6 \times 25$ mm.

6. Rejoin the case bottom and case top, and reinstall the 3 screws and holster.
Replacement of the fuses is seldom required. Burning of a fuse always results from improper operation.

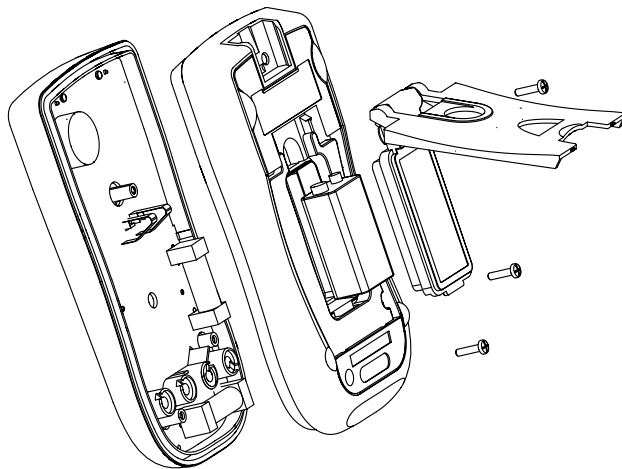



Figure 27

C. Replacing the Battery (see figure 27)



Warning

To avoid false readings, which could lead to possible electric shock or personal injury, replace the battery as soon as the battery indicator “  ” appears.

To replace the Meter’s battery:

1. Turn the Meter power off and remove all connections from the terminals.
2. Take the Meter out from the holster.
3. Remove the screw from the battery compartment and open the battery compartment.
4. Take out the battery and replace with a new 9V battery (NEDA1604, 6F22 or 006P).
5. Rejoin the battery compartment and the case bottom, and reinstall the screw and the holster.

UNI-T®

©Copyright 2009 Uni-Trend Group Limited.
All rights reserved.

Manufacturer:

Uni-Trend Technology (China) Limited
Dong Fang Da Dao
Bei Shan Dong Fang Industrial Development District
Hu Men Town, Dongguan City
Guang Dong Province
China
Postal Code: 523 925

Headquarters:

Uni-Trend Group Limited
Rm901, 9/F, Nanyang Plaza
57 Hung To Road
Kwun Tong
Kowloon, Hong Kong
Tel: (852) 2950 9168
Fax: (852) 2950 9303
Email: info@uni-trend.com
<http://www.uni-trend.com>